

Track System Specification

MT20NK-27

— MagTrack 20 series



◎ Basic Parameters

· Material:	Silicone Neon
· Coating:	Black (RAL9005)/White (RAL9003)
· Length:	1000mm,1500mm,5000mm optional
· IP grade:	IP20
· CCT:	2700,3000,4000K optional
· CRI:	90
· SDCM:	<3 Step (ANSI)
· Light efficiency:	45 LM/W
· Input voltage:	DC24V,DC48V
· Lighting direction:	Downward
· Dimming method:	Non-dimming,DALI-2,Tuya Bluetooth,CASAMBI
· Application:	Indoor
· Certification:	CE,UKCA,ROHS,Reach
· Warranty:	5 years

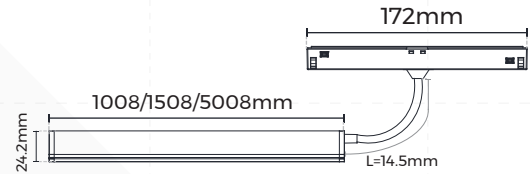

◎ Luminaire Parameters

Version	Model	Length	Input Voltage (V)	Max. Current (A)	Type Power (W)	Max. Power (W)	CRI	Beam Angle	CCT	Lumen (LM)
Normal	MT20NK-27	1000mm	24VDC /48VDC	0.4/0.2	9	9	>90	110°	2700K	370
									3000K	380
									4000K	405
Normal	MT20NK-27	1500mm	24VDC /48VDC	0.58/0.29	14	14.5	>90	110°	2700K	580
									3000K	590
									4000K	630
Normal	MT20NK-27	5000mm	48VDC	1	45	47	>90	110°	2700K	1860
									3000K	1900
									4000K	2020

Note:

1. The output data is based on the testing result of Ra90,4000k luminaires;
2. The tolerance of output data can be vary up to 10%;
3. The output data is typical value.

© MagTrack 20 Application

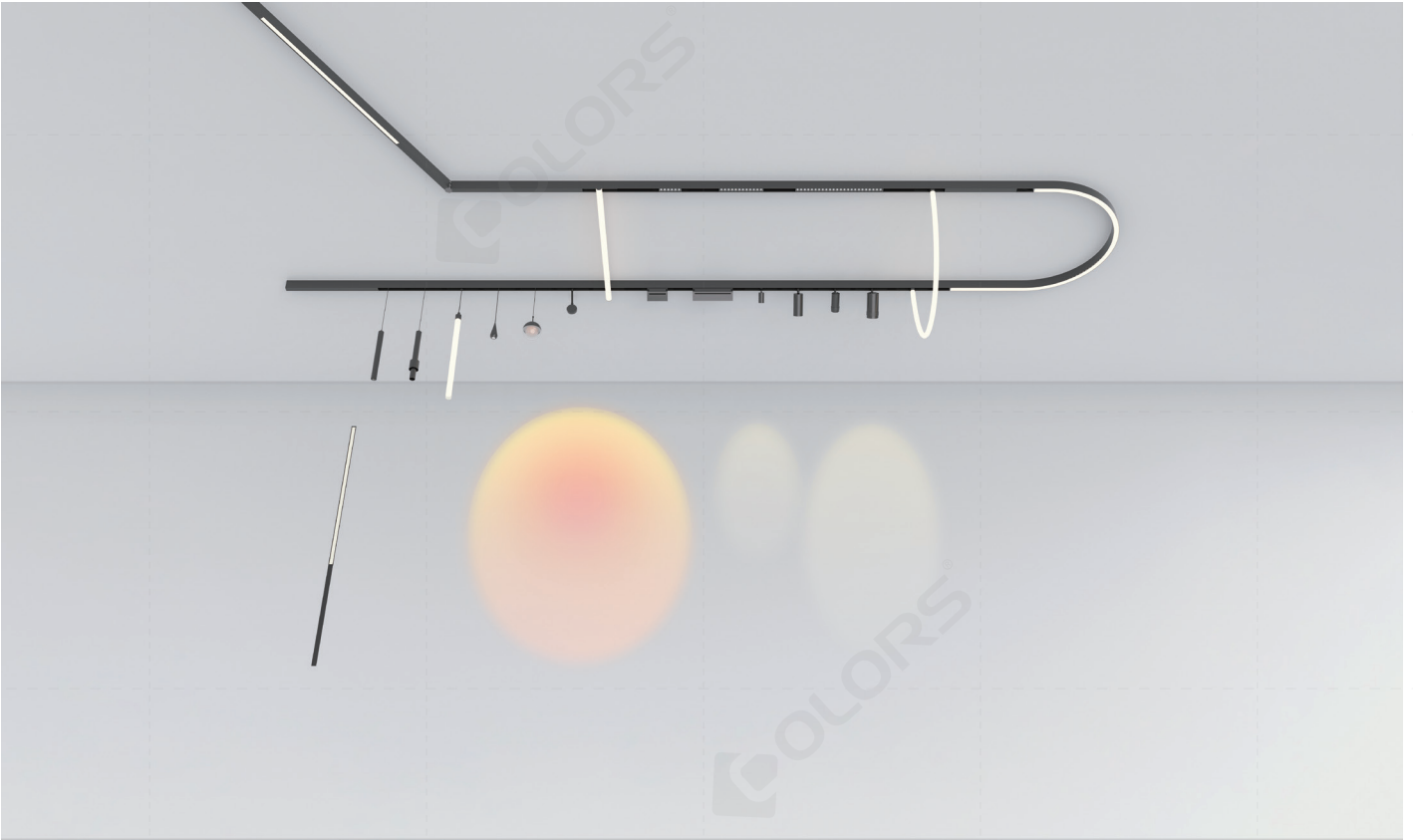

© Points to note

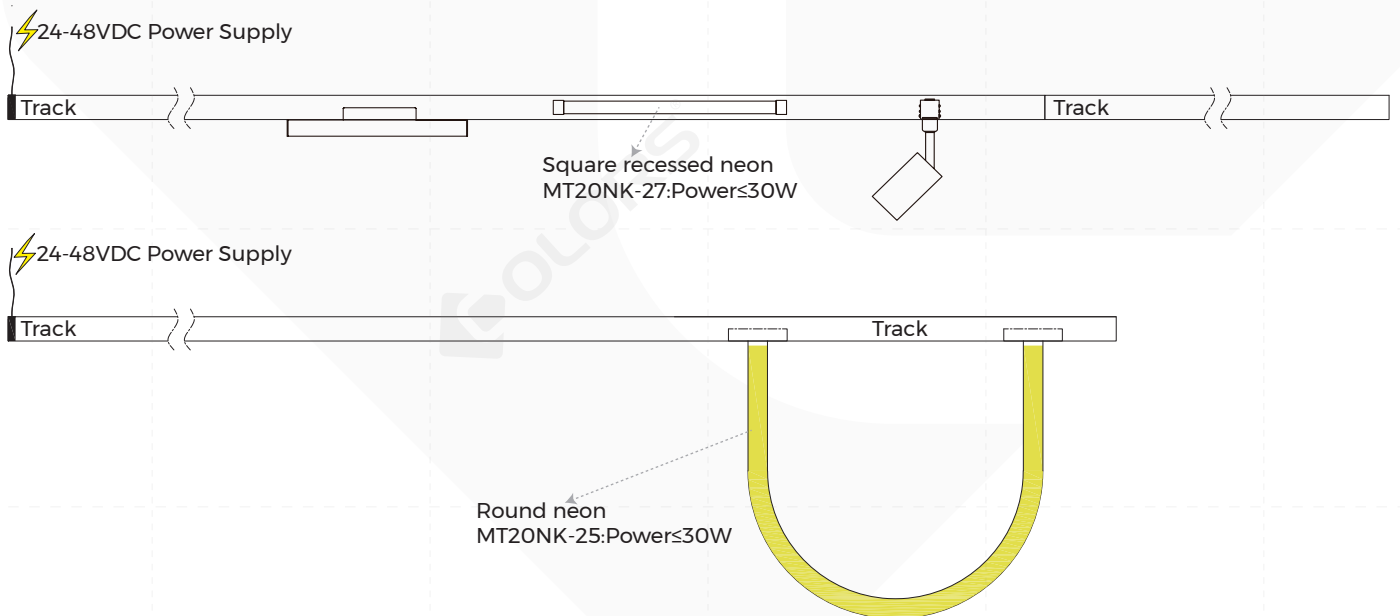

Supplementary power supplies are needed beside the Spotlights module / Decorative module / Linear modular under below one conditions:





1. Power of Square recessed neon MT20NK-27 > 30W
2. Power of Round neon MT20NK-25 > 30W
3. If a DC24V-48V power supply is used to power the track, then only luminaire modules with an input voltage of DC24V-48V can be selected.
4. If a DC48V power supply is used to power the track, then a luminaire module with an input voltage of DC24V-48V or DC48V can be selected.

◎ MagTrack 20 Product Accessories Information

Picture	Name	Model
	Trimless recessed track (9.5mm gypsum board)	TLS-MR2X0(A)
	Trimless recessed track (12.5mm gypsum board)	TLS-MR2X0(B)
	Trimless recessed track (Ordinary batching)	TLS-MR2X0(C)
	Pendant / Ceiling track	TLS-MS2X0
	Pendant / Ceiling track	TLS-MH2X0
	φ800mm 90° Trimless recessed curve track (9.5mm gypsum board)	TLS-MR208A90(A)
	φ1000mm 90° Trimless recessed curve track (9.5mm gypsum board)	TLS-MR210A90(A)
	φ1200mm 90° Trimless recessed curve track (9.5mm gypsum board)	TLS-MR212A90(A)
	φ800mm 90° Trimless recessed curve track (12.5mm gypsum board)	TLS-MR208A90(B)
	φ1000mm 90° Trimless recessed curve track (12.5mm gypsum board)	TLS-MR210A90(B)
	φ1200mm 90° Trimless recessed curve track (12.5mm gypsum board)	TLS-MR212A90(B)
	φ800mm 90° Ceiling/pendant curve track	TLS-MH208A90
	φ1000mm 90° Ceiling/pendant curve track	TLS-MH210A90
	φ1200mm 90° Ceiling/pendant curve track	TLS-MH212A90

Picture	Name	Model
	Power feeder of track	TLS-M261
	Electrical connector	TLS-M264
	I-shaped electrical connector (Recessed type)	TLS-M265
	I-shaped electrical connector (Surface)	TLS-M266
	End caps	EC-MR20
	End caps	EC-MS20
	End caps	EC-MH20
	Track blind cover	CV-M20FB
	Ceiling accessory	TLS-M271
	Pendant rope set	TLS-M272
	Ceiling screw	CL-01

Picture	Name	Model
	L-shaped corner (Downward)	L90-MR20(A)
	L-shaped corner (Inward)	L90N-MR20(A)
	L-shaped corner (Downward)	L90-MR20(B)
	L-shaped corner (Inward)	L90N-MR20(B)
	L-shaped corner (Downward)	L90-MR20(C)
	L-shaped corner (Inward)	L90N-MR20(C)
	L-shaped corner (Downward)	L90-MS20
	L-shaped corner (Inward)	L90N-MS20
	L-shaped corner (Downward)	L90-MH20
	L-shaped corner (Inward)	L90N-MH20
	L-shaped Adjustable corner (Downward)	L90-MH20(A)
	T-shaped Adjustable corner (Downward)	T90-MH20(A)
	X-shaped Adjustable corner (Downward)	X90-MH20(A)

Picture	Name	Model
	CASAMBI controller	T200EN1812-CAS-XX-BLDAV48
	Magnetic power supply (48V/100W)	MT20-HDRV100H48S-M
	Magnetic power supply (48V/200W)	MT20-HDRV200H48S-M
	48V Constant Voltage Power supply	BN-V48-XXXP

Note:

- 1, Please refer to the accessory list table for detailed parameters.
- 2, Different tracks need to be used with corresponding accessories

©MagTrack 20 Product Economical Accessories Information

Picture	Name	Model
	Trimless recessed track (Ordinary batching)	TLS-ECO-MR2X0
	Trimless recessed track (12.5mm gypsum board)	TLS-ECO-MR2X0(A)
	Pendant / Ceiling track	TLS-ECO-MS2X0
	Pendant / Ceiling track	TLS-ECO-MH2X0
	End caps	EC-ECO-MS20
	End caps	EC-ECO-MH20
	L-shaped corner (Inward)	L90-ECO-MS20
	L-shaped corner (Inward)	L90-ECO-MH20
	Pendant rope set	TLS-ECO-M280
	I-shaped electrical connector (Surface)	TLS-ECO-M281

Note:

- 1,Please refer to the accessory list table for detailed parameters.
- 2,Different tracks need to be used with corresponding accessories

◎ NeonTrack Application

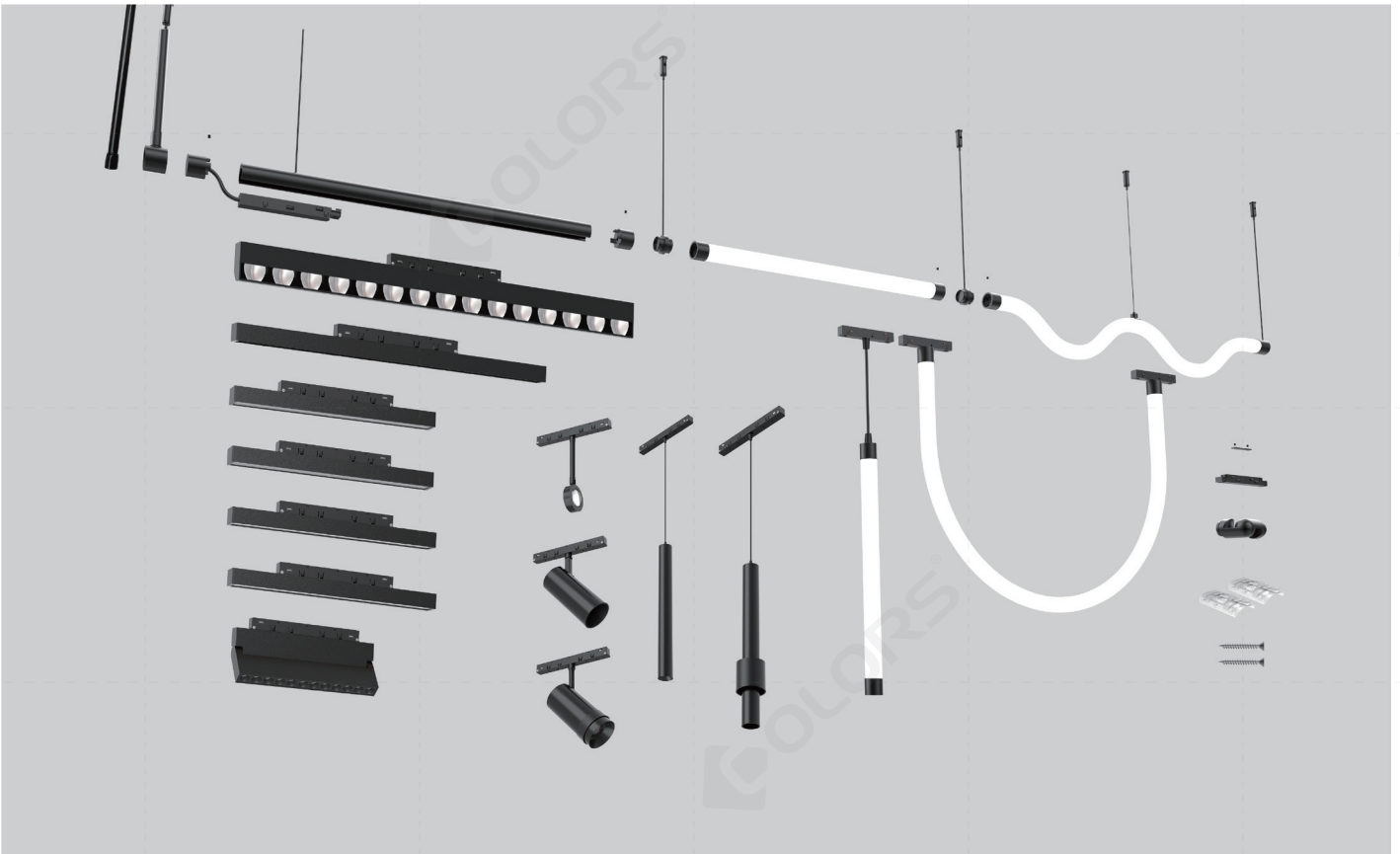

◎ Points to note

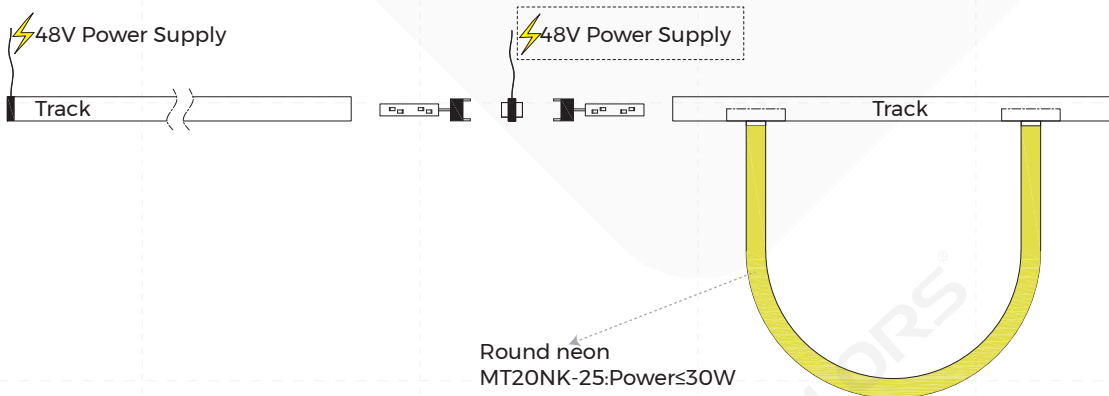
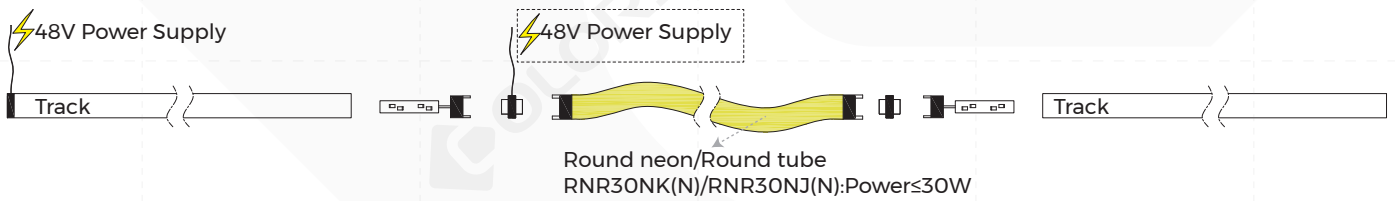
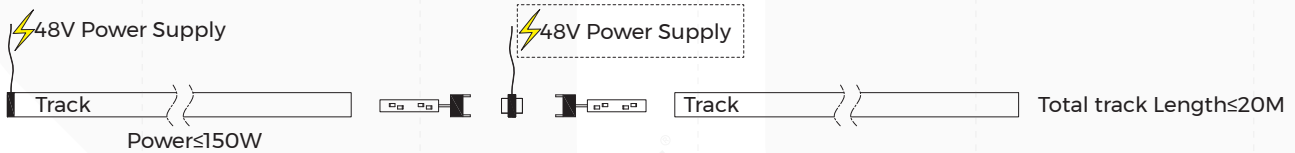





Supplementary power supplies are needed beside the Spotlights module / Decorative module / Linear modular under below one conditions:

1. Load $> 150W$ on the track or Total track length $> 20M$
2. Power of Round neon/Round tube $> 30W$

©NeonTrack Product Accessories Information

Picture	Name	Model
	Round track	TLS-R6X0
	End cap	TLS-R600
	Turned connector	TLS-R860
	Straight connector	TLS-R861
	Power feeder of track	TLS-R862 (N)
	I-shaped electrical connector	TLS-R863 (N)
	Female end cap	TLS-R865
	Ceiling screw	CL-21
	Track pendant rod	PG-1
	Track pendant cable	PN-D

Picture	Name	Model
	Ceiling accessories	CL-18
	Pendant accessories	TLS-R892
	Neon lights Pendant rod (1-2 Meter Adjustable)	TLS-R893
	Neon lights Pendant rod (0.5-1 Meter Adjustable)	TLS-R895
	48V Constant Voltage Power supply	BN-V48-XXXP

Note:

- 1, Please refer to the accessory list table for detailed parameters.
- 2, Different tracks need to be used with corresponding accessories

◎Packing

Model	Size (mm/box)	Quantity /box	Quantity /carton	NW (kg/box)	NW (kg/carton)	GW (kg)	Size (mm/carton)
TLS-MT20NK271000-099040FI-NBW	/	1	4	1.2	4.8	4.88	410*410*260 [16.14"*16.14"*10.24"]
TLS-MT20NK271500-149040FI-NBW	/	1	3	1.6	4.8	4.95	410*410*260 [16.14"*16.14"*10.24"]
TLS-MT20NK275000-459040FI-NBW	/	1	2	4.8	9.6	9.70	410*410*260 [16.14"*16.14"*10.24"]

◎Model Code

TLS	-	M	T	20	N	K	271000	-	09	90	40	FI	-	N	B	W	
System TLS: Track Light System		Series M: Magnetic Module	Installation T: Track	Track Size 20: 20mm	Diffuser Type N: Neon	Diffuser Nature K: Flexible Tube	Length 271000: \varnothing 25x1000mm 271500: \varnothing 25x1500mm 275000: \varnothing 25x5000mm		Type Power 09: 9W 14: 14W 45: 45W	CRI 90: Ra>90	CCT 27: 2700K 30: 3000K 40: 4000K	Beam angle FI110°		Dimming Method N: Non-Dimming D: 1-10V Dimming A: DALI Dimming X: No Power	Color B: Black W: White		Diffuser Color W: White

◎Attentions

1. Non-professionals are prohibited from installing, disassembling and repairing the product.
2. Avoid scratching, distortion and irregular bending of the product during installation; otherwise it may cause irreparable damage to the product.
3. Please use professional cutting tools when cutting
4. Do not use any acid or alkaline adhesive to fix products
5. The product is only suitable for indoor dry places, can not be used in outdoor, seaside or wet environment.
6. PC features: Each 10°C rise or drop will make diffuser extend or shrink 0.8mm/m, please confirm before processing and use